



Coaxial SMA Type Isolator 3400 ~ 3600 MHz

ADI350CSPH

Features

- 21dB typical Isolation, 0.35dB typical Insertion Loss at room temperature.
- Custom products available with alternate configurations such as attenuators, high power terminations, reverse circulation etc.
- Designed for Wireless Telecommunications Systems.
- RoHS Compliant

Electrical Characteristics

Parameter	Units	Specifications
Frequency	MHz	3400 ~ 3600
Insertion Loss	dB Max.	0.45
Isolation	dB Min.	19
VSWR	Max.	1.29 : 1
Temperature	°C	- 30 ~ +85
FDW./REV. Power	W Max.	150/100
Input/Output Impedance	Ω	50

Mechanical Dimensions

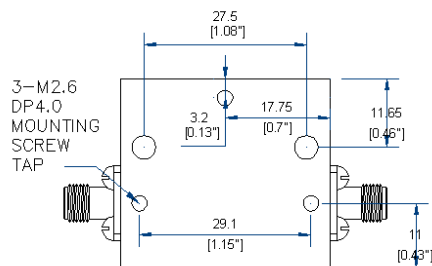
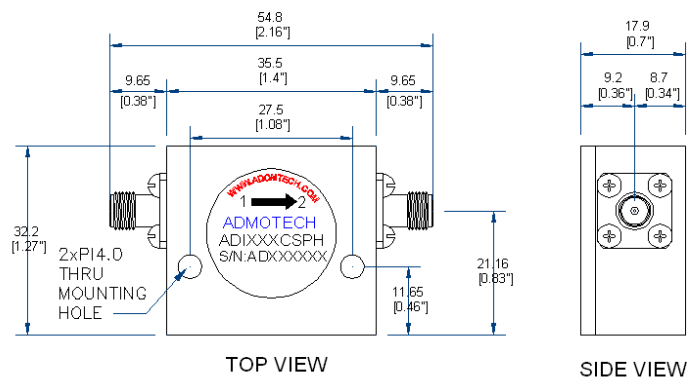

Unit:mm[inch]
Tolerance : ±0.2mm



If you do not find appropriate frequency range, Please contact with sales@admotech.com