



DROP-IN Isolator 1805 ~ 1880 MHz

ADI184DST

Features

- 23dB typical Isolation, 0.25dB typical Insertion Loss at room temperature.
- Custom products available with alternate configurations such as attenuators, high power terminations, reverse circulation etc.
- Designed for Wireless Telecommunications Systems.
- RoHS Compliant

Options

The customers can choose as follows

- Direction : Clockwise(Default) or Counter Clockwise.
- T : Termination, A3 : -30dB Attenuator for detection, A2 : -20dB Attenuator for detection

Electrical Characteristics

Parameter	Units	Specifications
Frequency	MHz	1805 ~ 1880
Insertion Loss	dB Max.	0.30
Isolation	dB Min.	21
VSWR	Max.	1.195 : 1
Temperature	°C	- 30 ~ +85
FDW./REV. Power	W Max.	150/100
Input/Output Impedance	Ω	50

Mechanical Dimensions

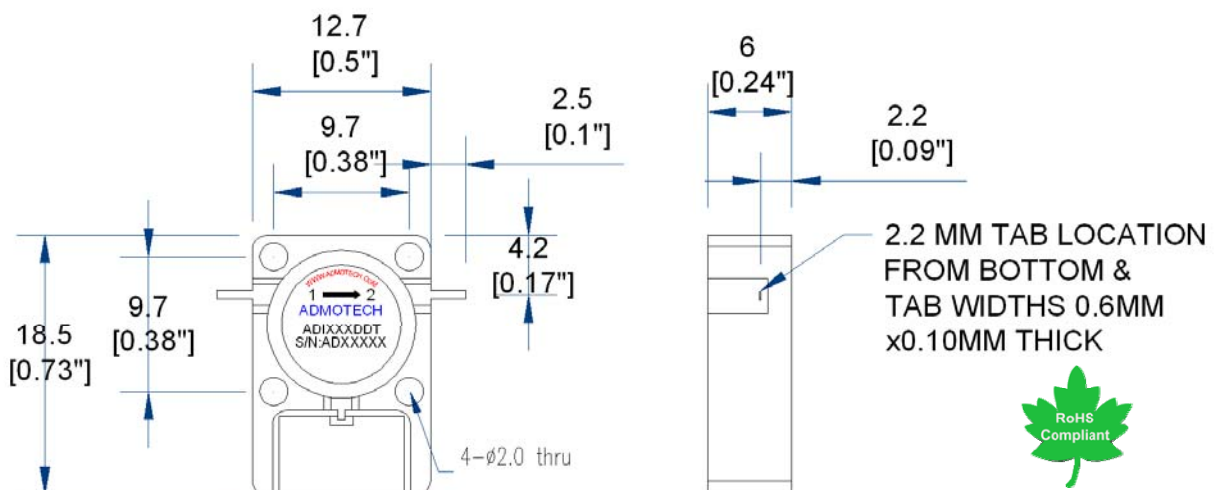

Unit: mm[inch]
Tolerance: ±0.2mm

If you do not find appropriate frequency range, Please contact with sales@admotech.com